

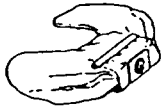





Cloth Inner Bags

Celebrity 43662001	Cloth Bag		Shoulder Vac 43662002	Cloth Reusable K Bag	
Tempo 43662024	Cloth Reusable R Bag		Commercial 43667034 43667051 43667053	Cloth Reusable A Bag Cloth Reusable Y Bag Cloth Reusable Z Bag	
Portapower 43662023	Cloth Bag				

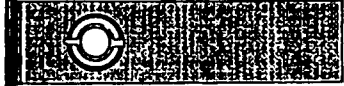

Bearings







Convertible & Industrial Uprights

1. 42934002 Upper Bearing
2. 19829 Lower Bearing - Early
3. 43267006 Lower Bearing - 8mm - Later

1. 42193025 Motor Brush Hsg. - Upper
2. 43551008 Motor Hsg. - Lower







Dial-A-Matic & Slimline

1. N/A End Cap Bearing
2. 12059 Motor Bearing & Brush Housing
3. 12123 Main Casting Bearing

Conquest

1. 37191090 Motor Housing
2. 24152807 Bearing
- 43588018 Fan Chamber w/Bearing



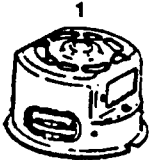
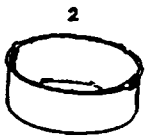

Celebrity

1. 169707 Motor Housing - Upper - 1 Fan Motor
- 169706 Motor Housing - Upper - 2 Fan Motor
2. 41823002 Motor Housing - Lower - 1 Fan Motor
- 41823001 Motor Housing - Lower - 2 Fan Motor

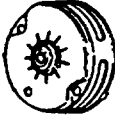

Portapower & Spirit

1. 42937003 Motor Housing - Upper
2. 37191085 Motor Housing - Lower

Dimension

1. 42192016 Motor Housing
2. 43551013 Diffuser

Quik-Broom II

1. 42196005 Motor Brush Housing Assem. - Upper

Concept/PowerMAX

1. 43588001 Fan Chamber
2. 42193004 Motor Housing

